



Coil D36 class H - 20W

Type

COIL
FVBB-36

COIL

9.1

Standard

DIN43650
ISO4400

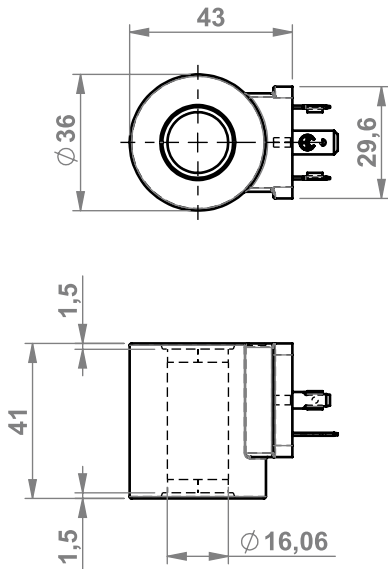

On demand

Kostal
M27x1

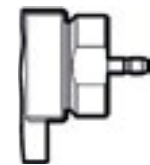

AMP
Junior H



Deutsch
DT04-2P-V

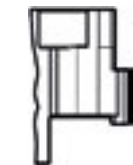
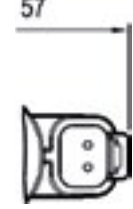

AMP
Superseal-V

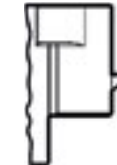

Single wire
Ø6,3 L=300

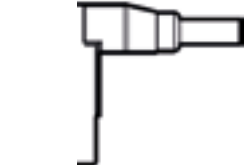
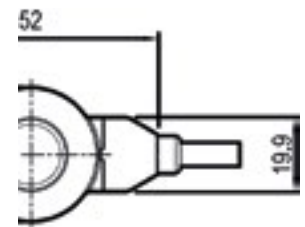

Technical characteristics

<i>In general</i>			
Weight	0,18 kg		
Ambient operating temperature	-30 / +90 °C		
Protection rate	IP65	Connector DIN43650 - ISO4400 Connector Kostal M27x1 Single wire Ø 6,3 L=300	
	IP67	Connector AMP Junior H	
	IP69K	Connector Deutsch DT04-2P-V Connector AMP Superseal-V	
<i>Electrical</i>			
Voltage	Nominal	12Vdc	24Vdc
Resistance (±7%)	a T = 20°C	7,4 Ohm	28,4 Ohm
Power		20 W	20 W
Current	I max.	1,67 A	0,83 A
	I Nom.	1,04 A	0,54 A